

FEFCO ULULARARASI KUTU KODLARI

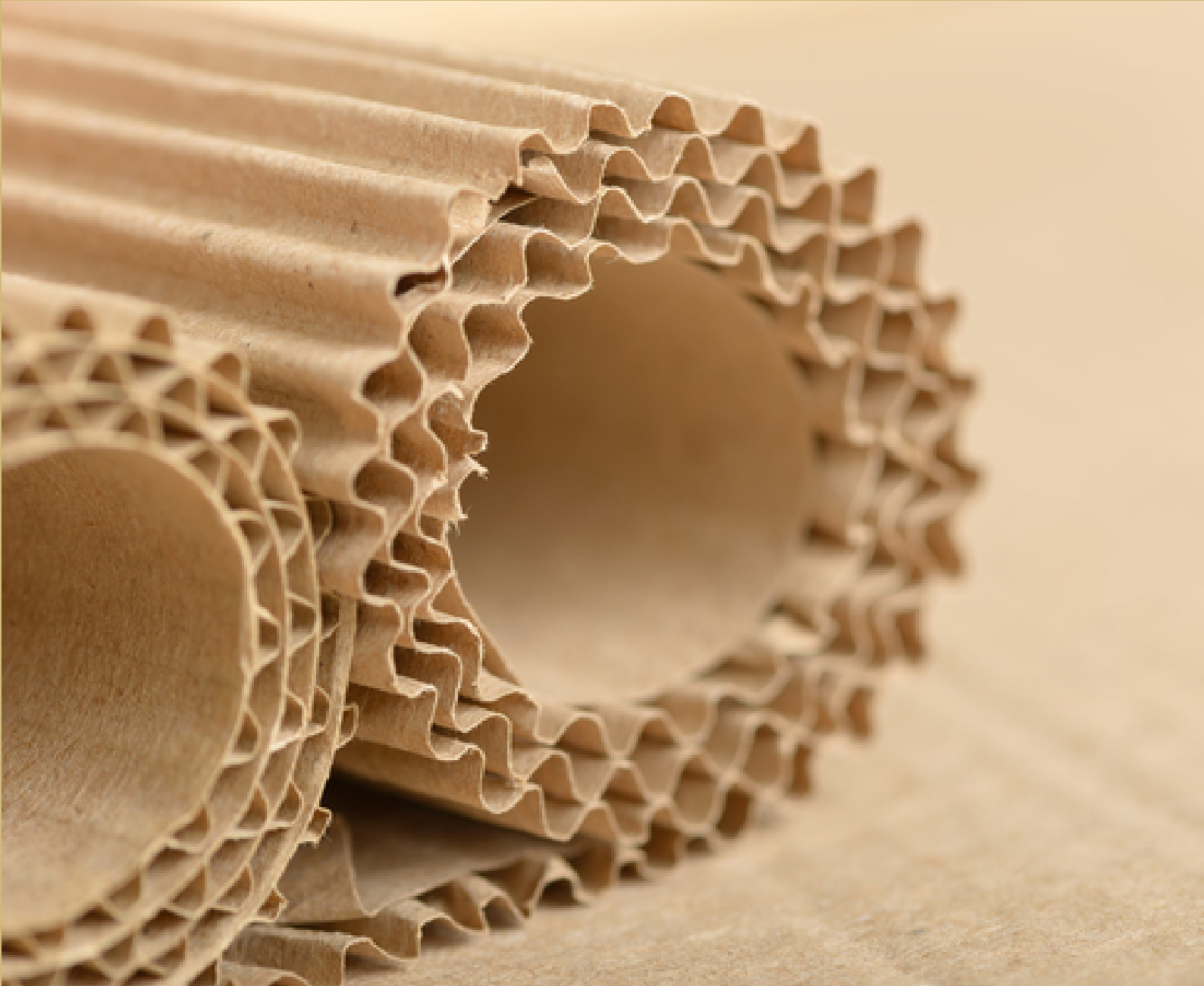

FEFCO 0100

Ticari Rulolar ve Levhalar.

0100

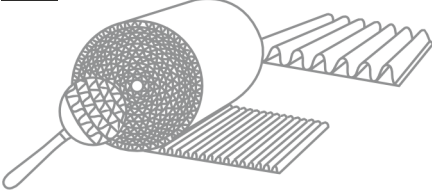

0110

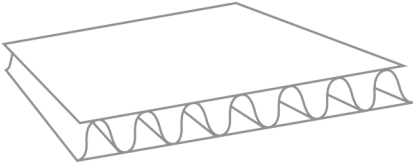

FEFCO 0200

Oluklu Tip Kutular

0200 | M/A

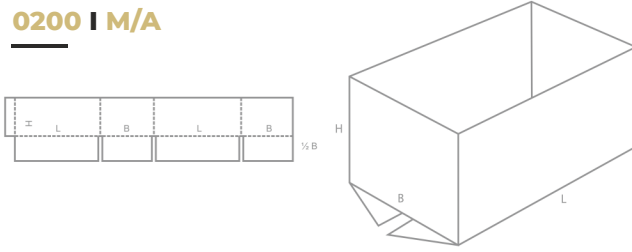

0201 | M/A

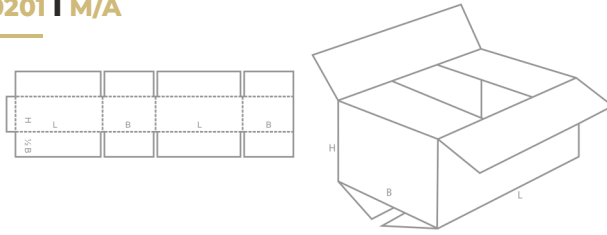

0202 | M/A

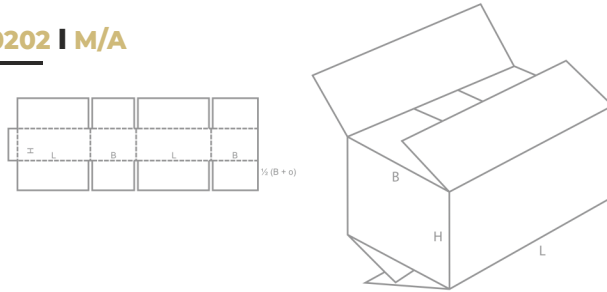

0203 | M/A

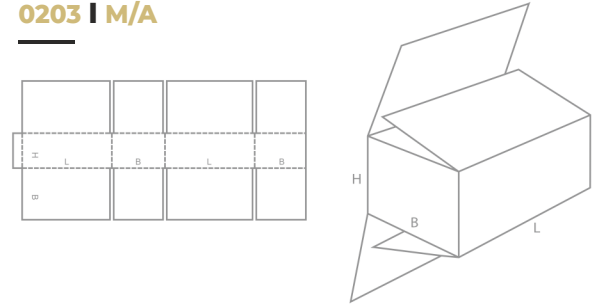

0204 | M/A

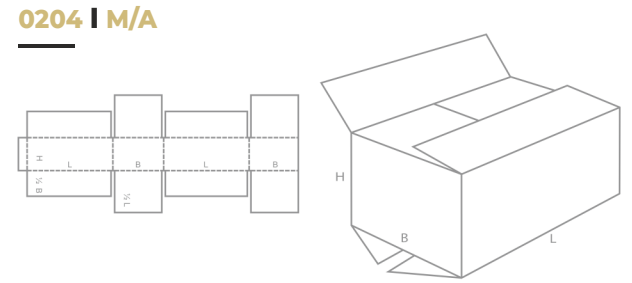

0205 | M/A

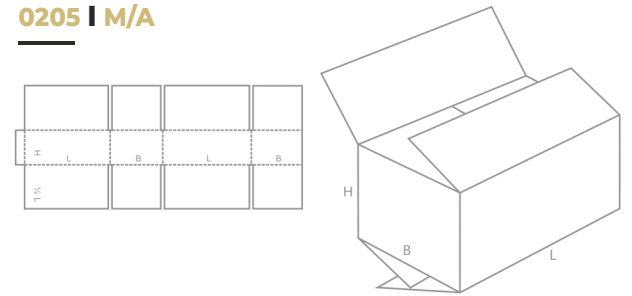

0206 | M/A

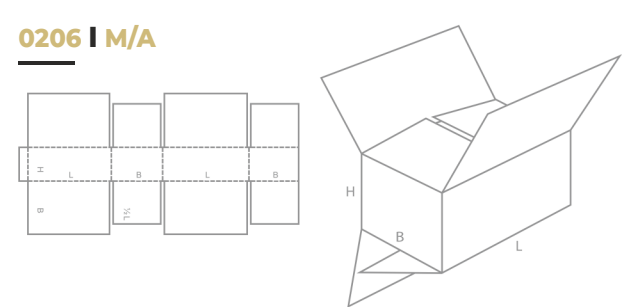

FEFCO 0200

Oluklu Tip Kutular

0207 | M

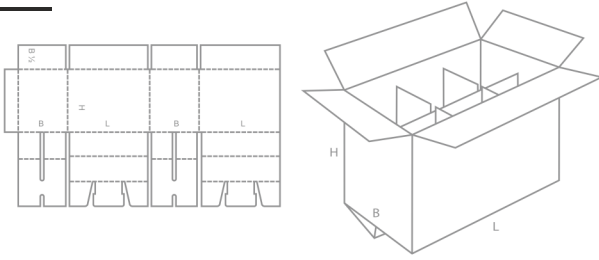

0211 | M

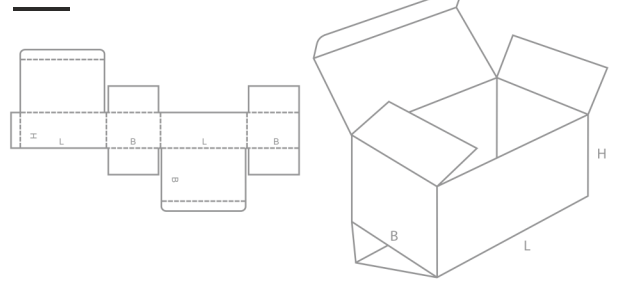

0208 | M

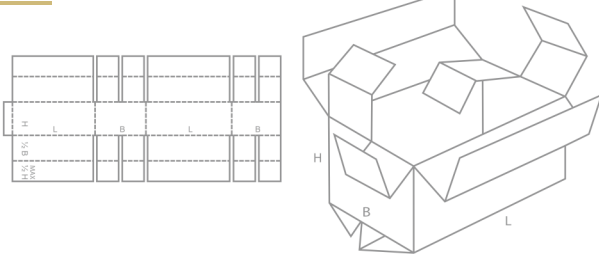

0212 | M/A

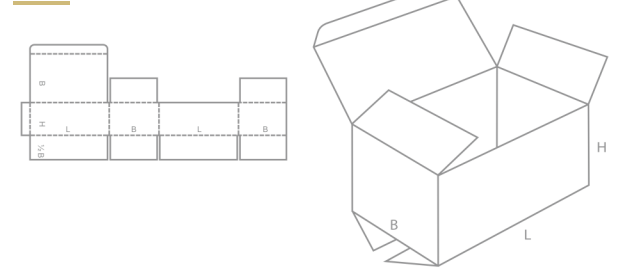

0209 | M/A

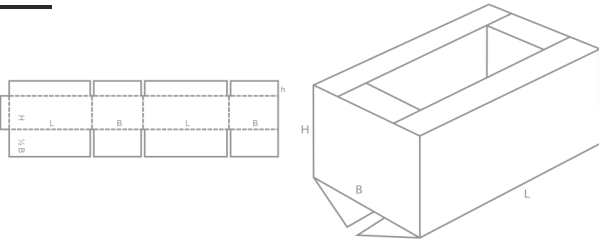

0214 | M

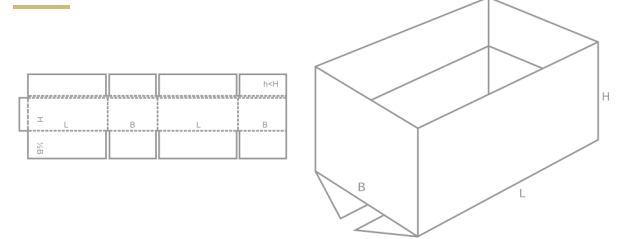

0210 | M

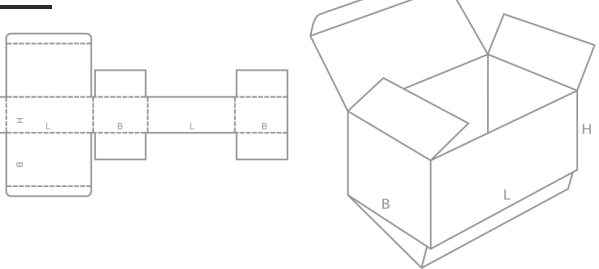

0215 | M

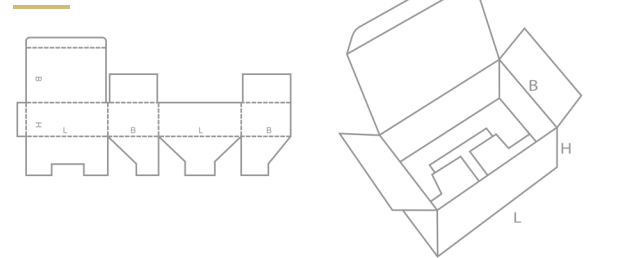

FEFCO 0200

Oluklu Tip Kutular

0216 | M

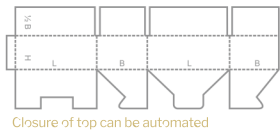

Closure of top can be automated

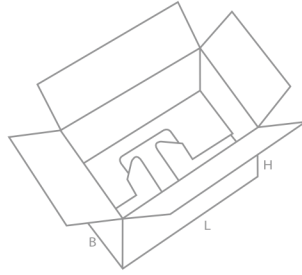

0226 | M

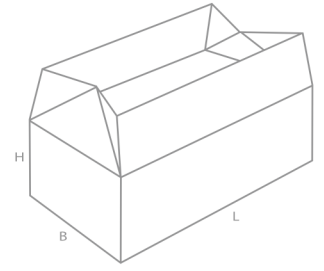
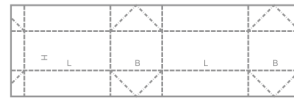

0217 | M

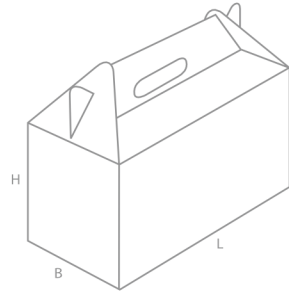
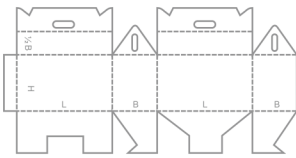

0227 | M

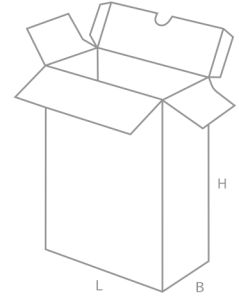
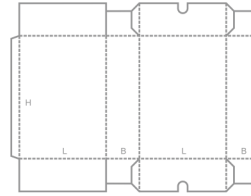

0218 | M

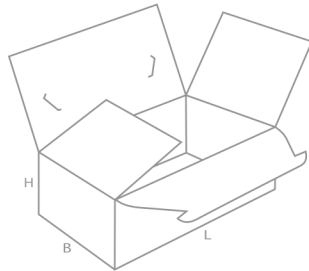
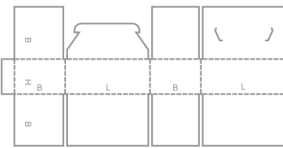

0228 | M/A

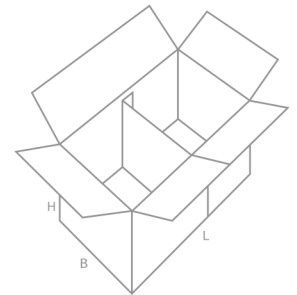

0225 | M

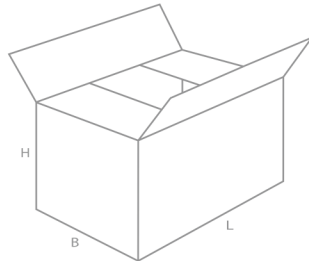
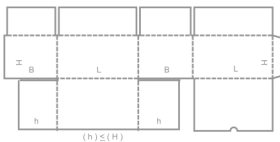

0229 | M

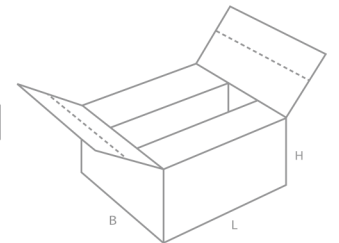
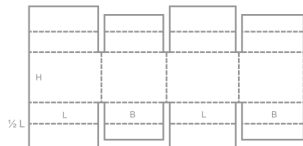

FEFCO 0200

Oluklu Tip Kutular

0230 | M

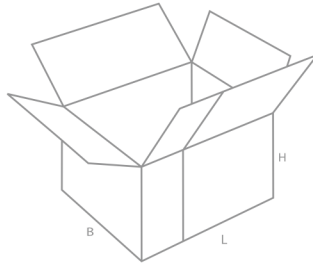
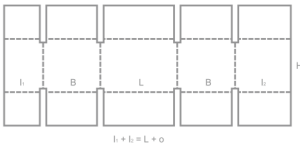

0231 | M

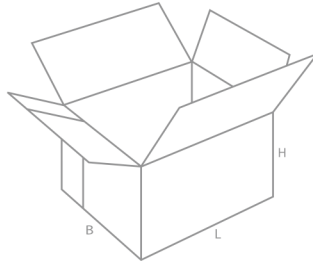
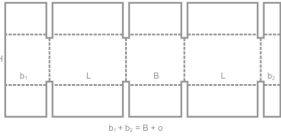

FEFCO 0300

Teleskop Tipi Kutular

0300 | M/A

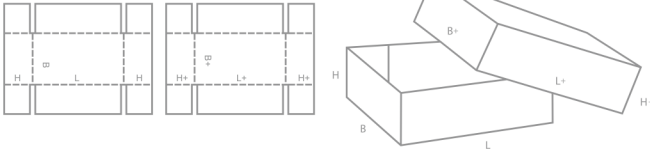

0301 | M/A

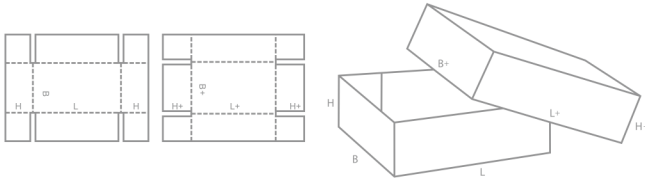

0302 | M

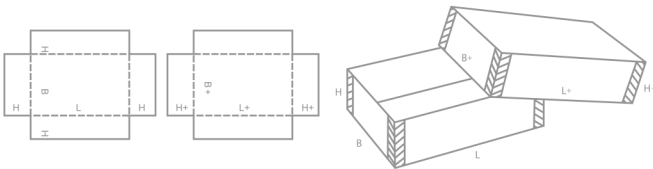

0303 | M

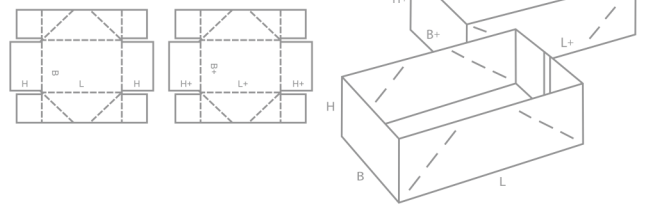

0304 | M

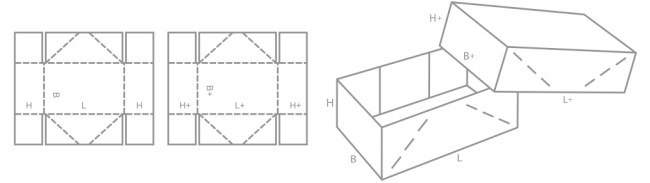

0306 | M/A

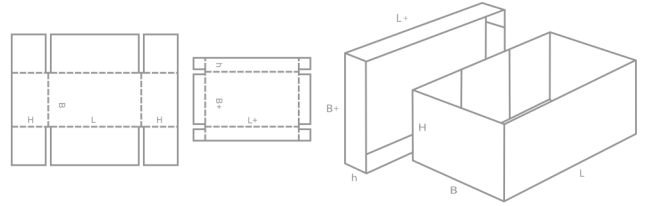

0307 | M

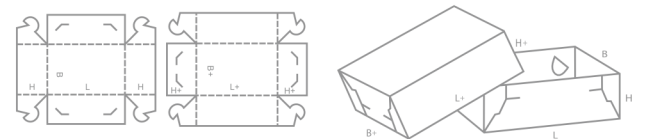

FEFCO 0300

Teleskop Tipi Kutular

0308 | M

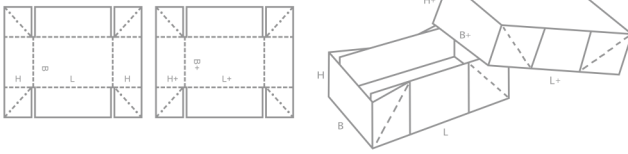

0309 | M

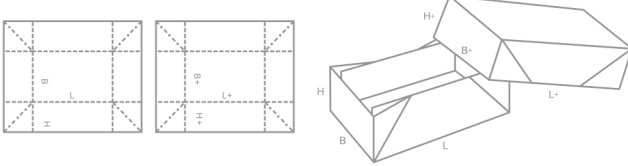

0310 | M+A

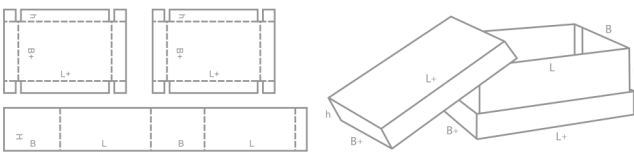

0312 | M/A

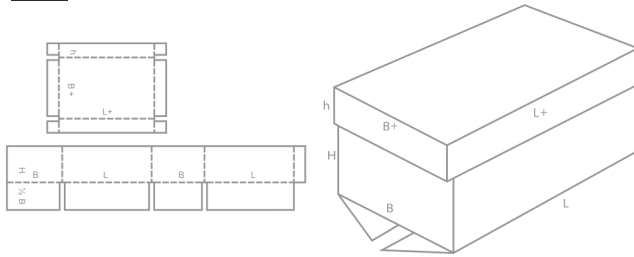

0313 | M/A

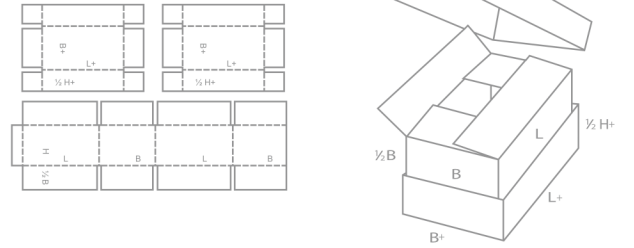

0314 | M

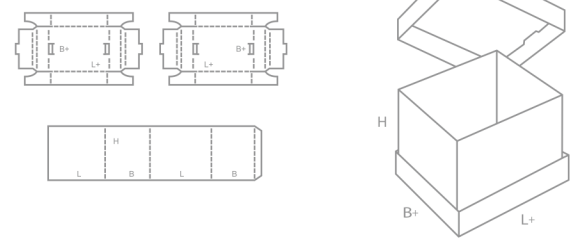

0320 | M/A

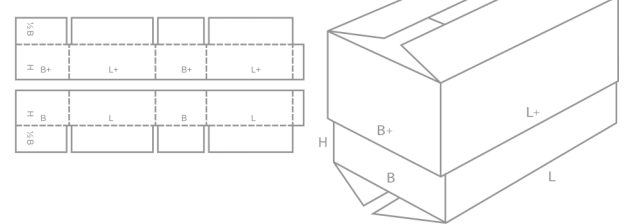

0321 | M

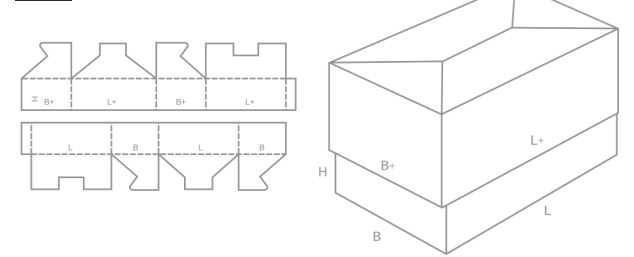

FEFCO 0300

Teleskop Tipi Kutular

0322 | M

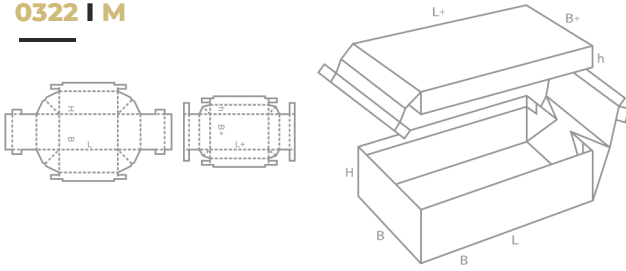

0331 | M/A

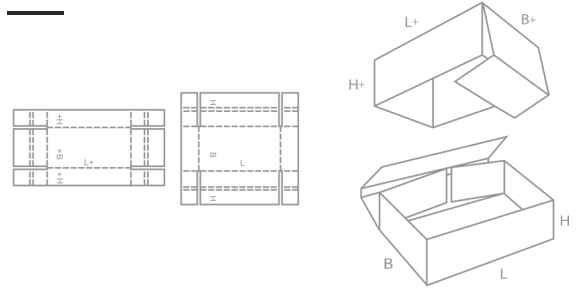

0323 | M

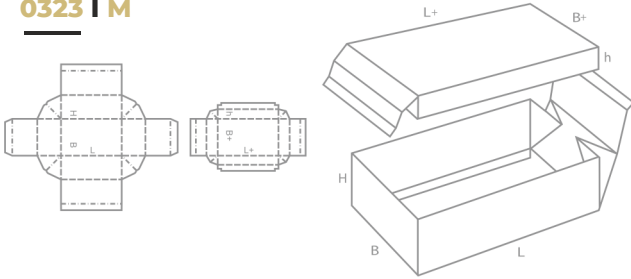

0350 | M

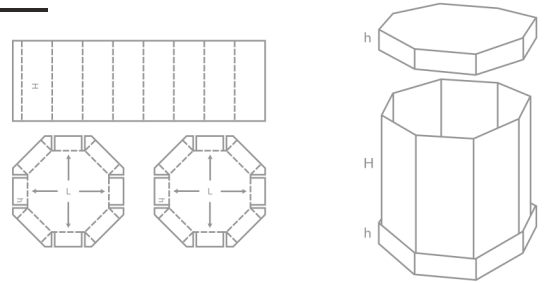

0325 | A

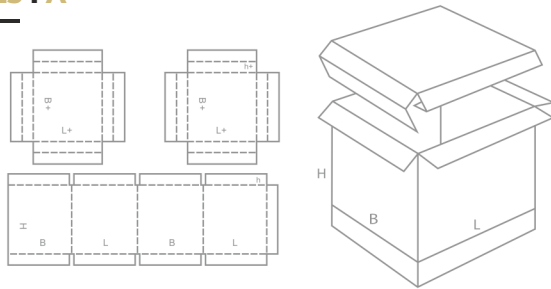

0351 | M/A

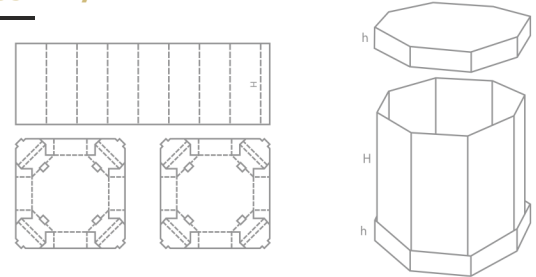

0330 | M/A

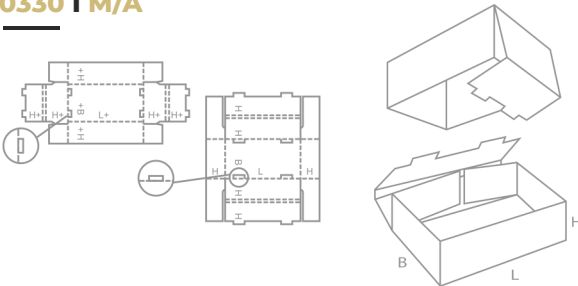

0352 | M/A

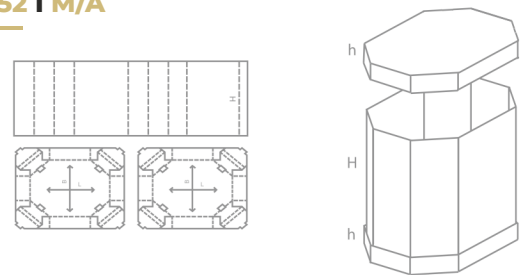

FEFCO 0400

Klasör Tipi Kutular ve Tepsiler.

0400 | M

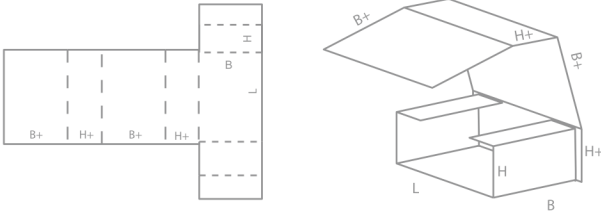

0401 | M

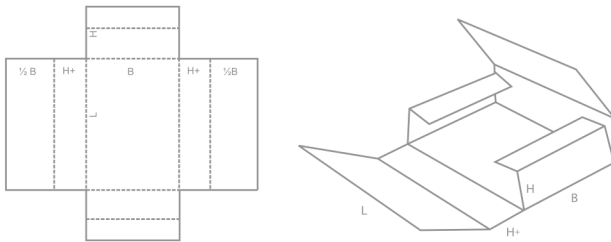

0402 | M

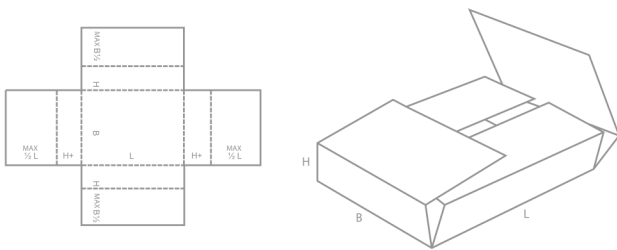

0403 | M

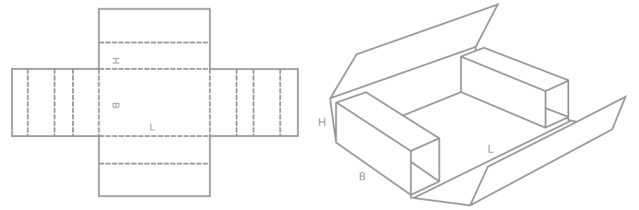

0404 | M

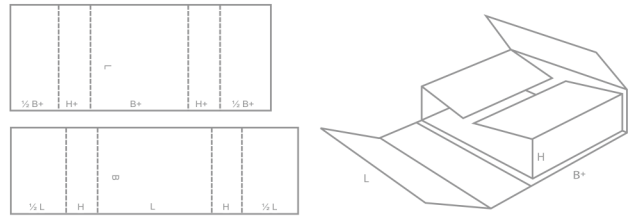

0405 | M

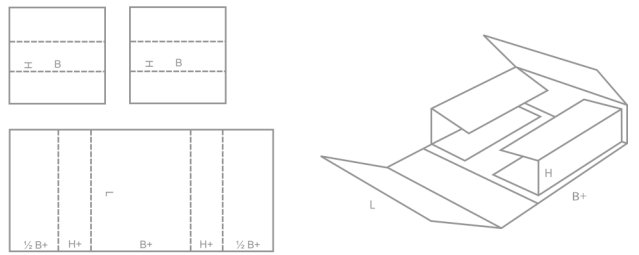

0406 | A

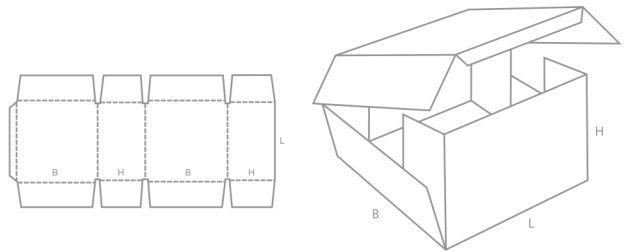

FEFCO 0400

Klasör Tipi Kutular ve Tepsiler

0409 | M

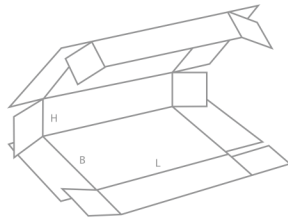
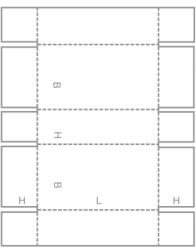

0413 | M/A

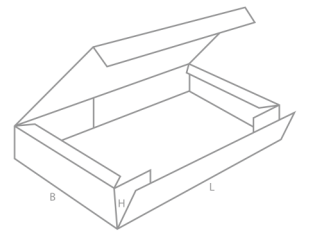
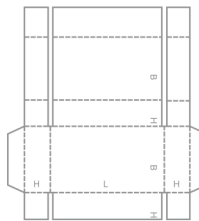

0410 | M/A

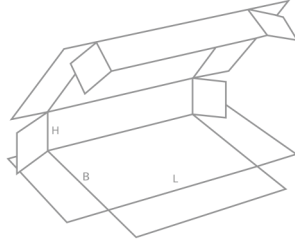
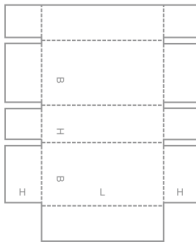

0415 | M/A

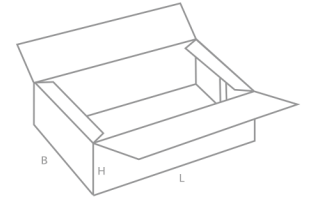
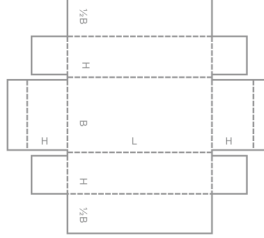

0411 | M/A

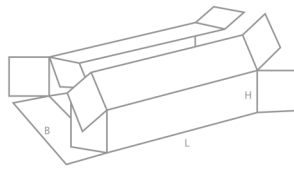
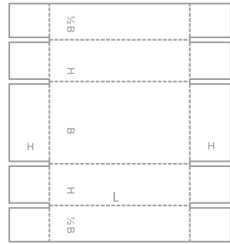

0416 | M

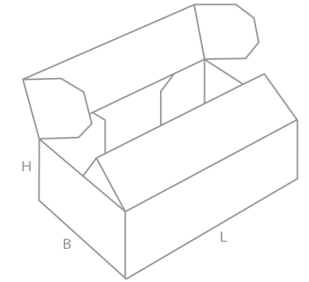
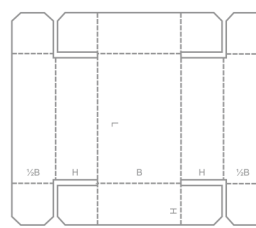

0412 | M

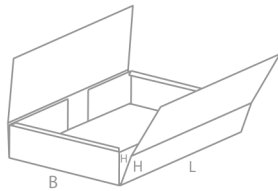
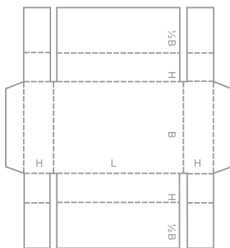

0420 | M/A

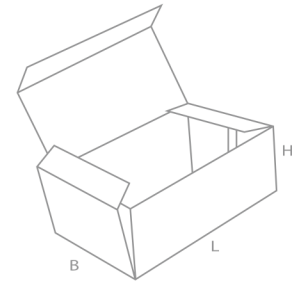
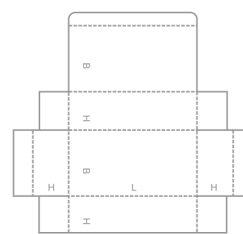

FEFCO 0400

Klasör Tipi Kutular ve Tepsiler

0421 | M/A

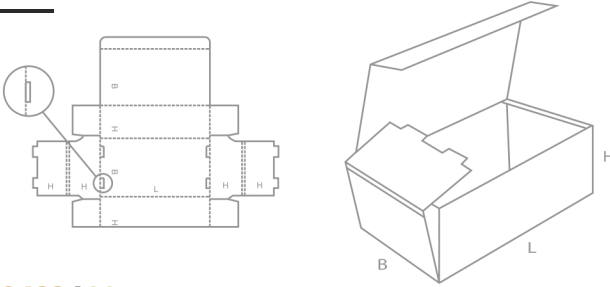

0425 | M/A

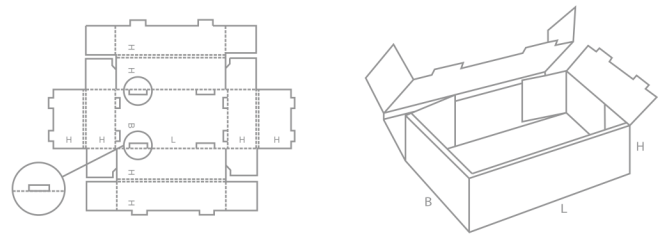

0422 | M

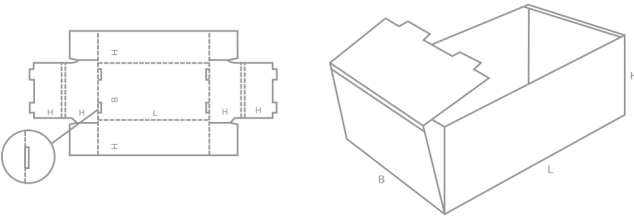

0426 | M/A

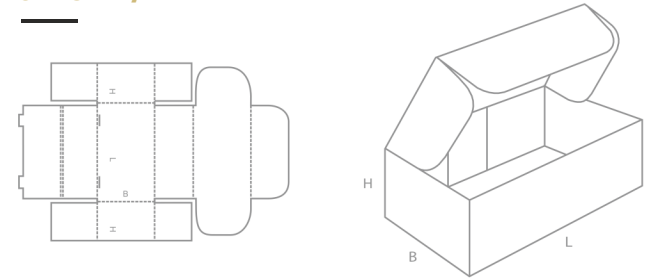

0423 | M

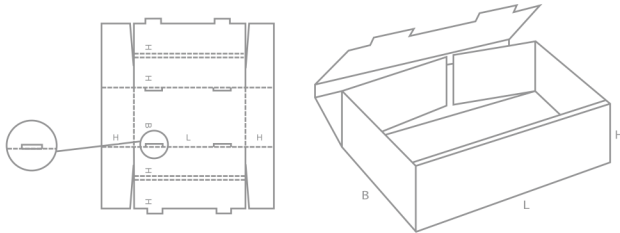

0427 | M/A

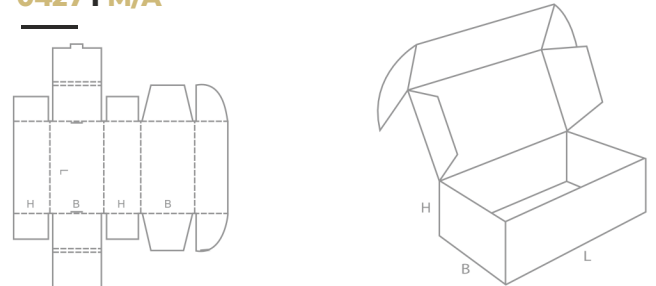

0424 | M

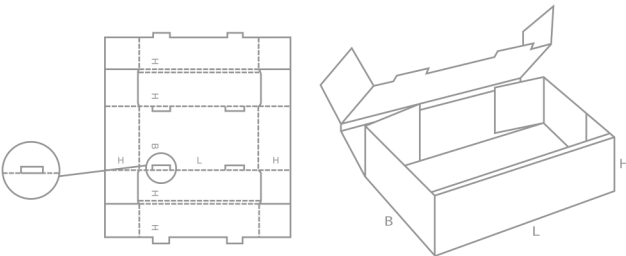

0428 | M/A

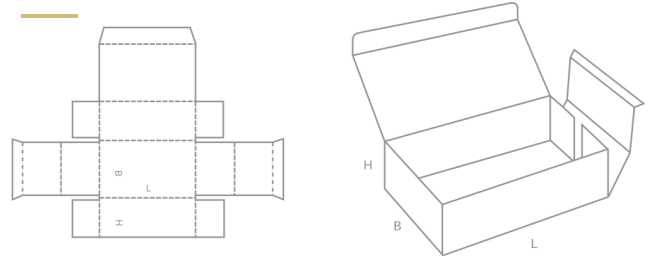

FEFCO 0400

Klasör Tipi Kutular ve Tepsiler

0429 | M

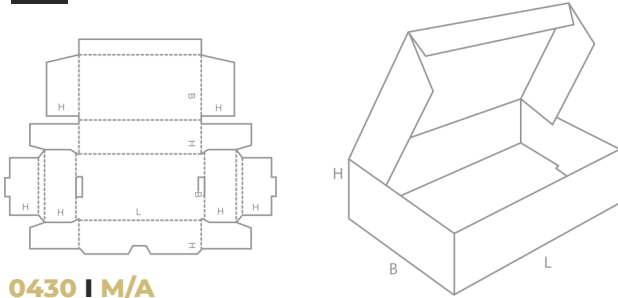

0433 | M

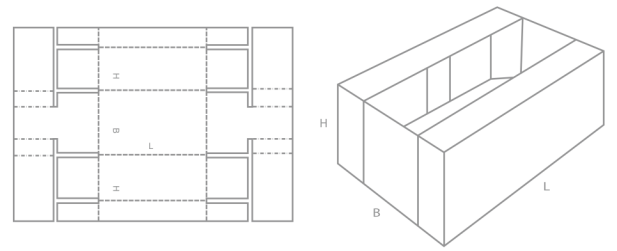

0430 | M/A

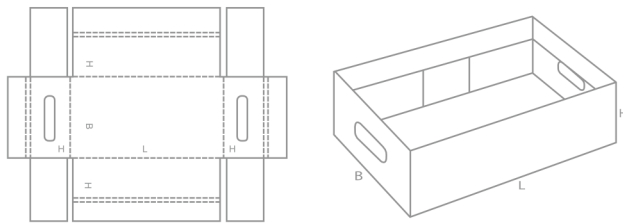

0434 | M

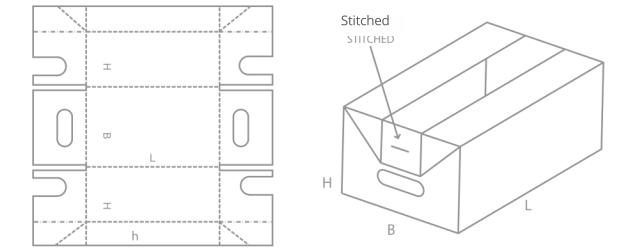

0431 | M

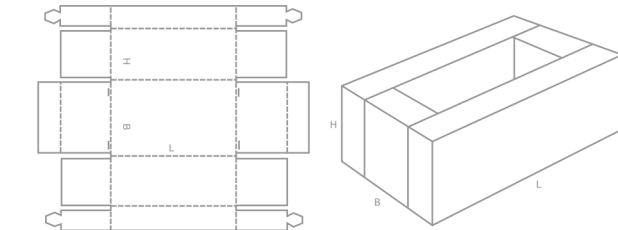

0435 | M/A

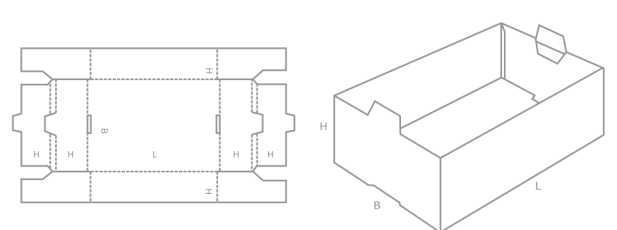

0432 | M

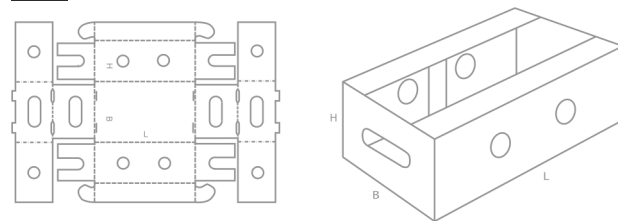

0436 | M

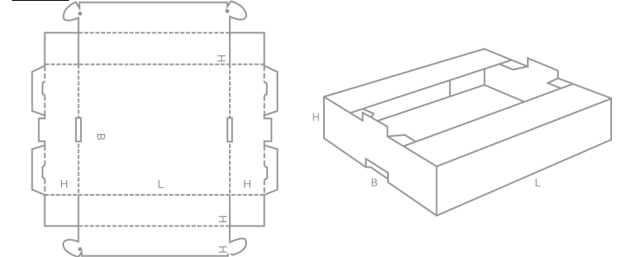

FEFCO 0400

Klasör Tipi Kutular ve Tepsiler

0437 | M

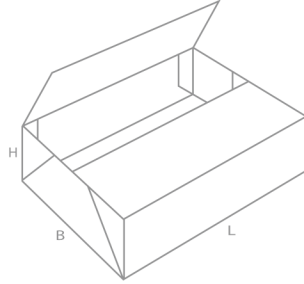
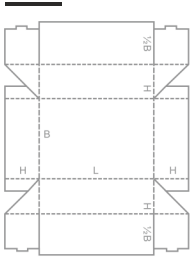

0443 | M

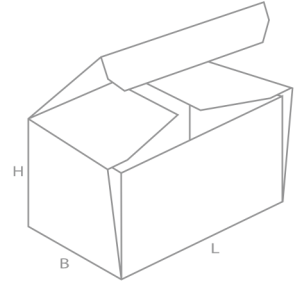
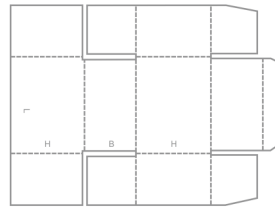

0440 | A

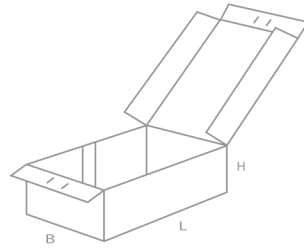
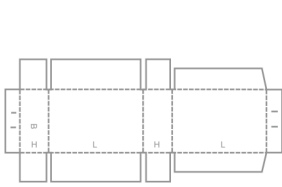

0444 | M

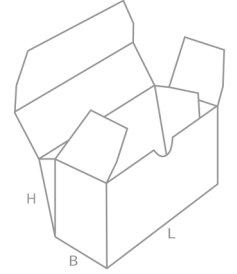
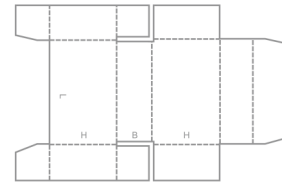

0441 | A

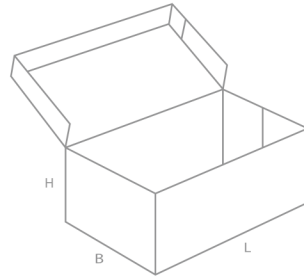
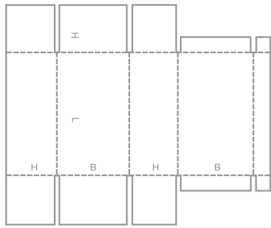

0445 | M

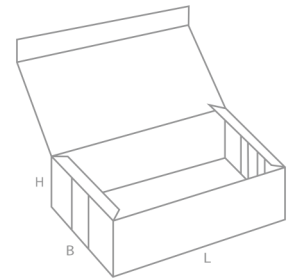
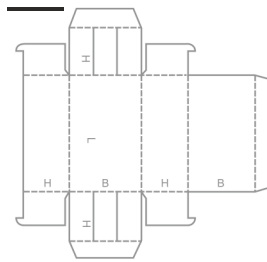

0442 | M

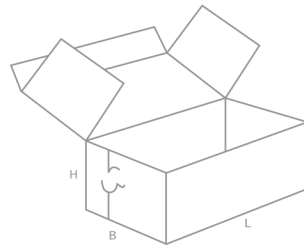
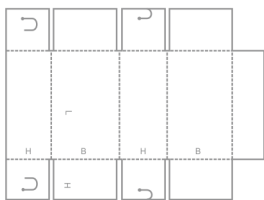

0446 | M

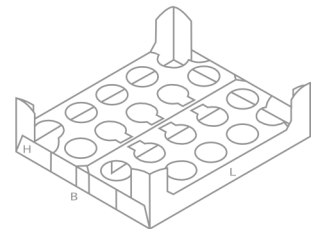
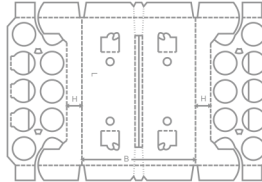

FEFCO 0400

Klasör Tipi Kutular ve Tepsiler

0447 | M

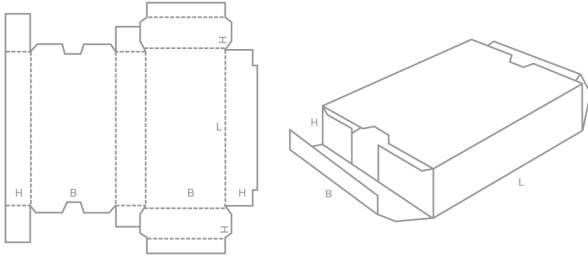

0451 | M

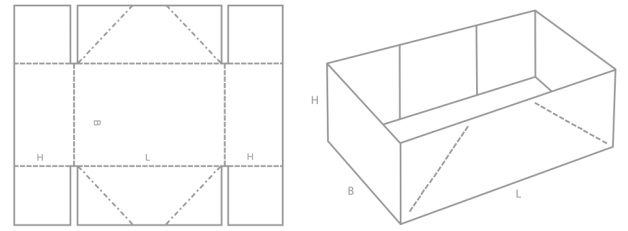

0448 | M

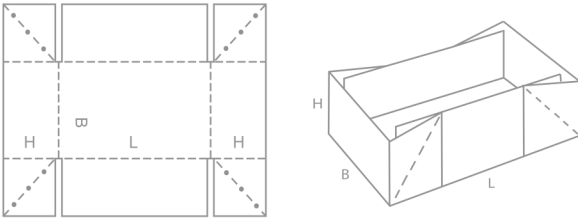

0452 | A

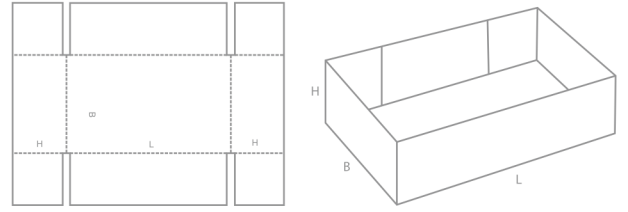

0449 | M

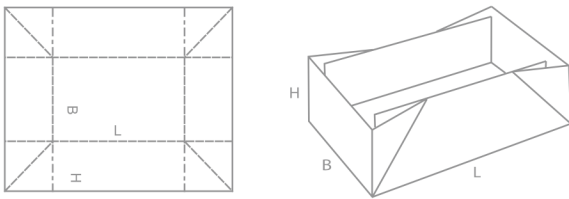

0453 | A

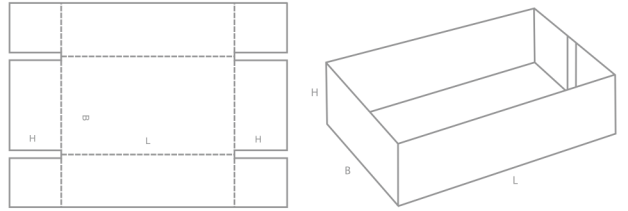

0450 | M

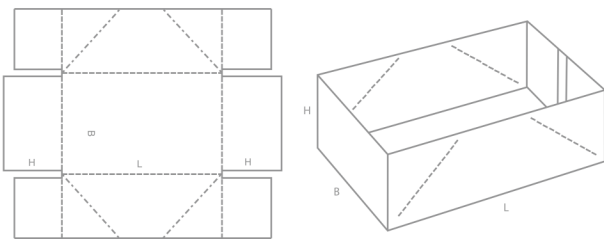

0454 | M

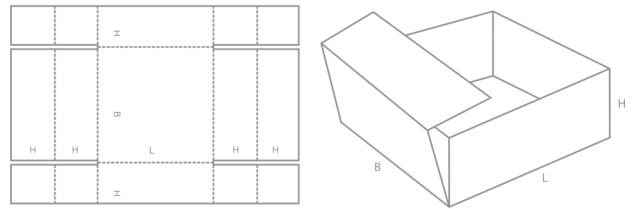

FEFCO 0400

Klasör Tipi Kutular ve Tepsiler

0455 | M

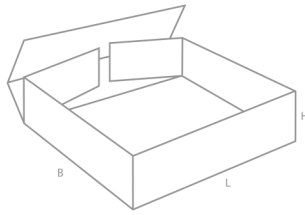
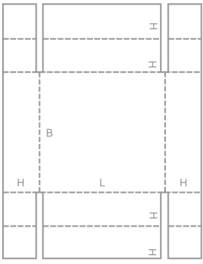

0459 | A

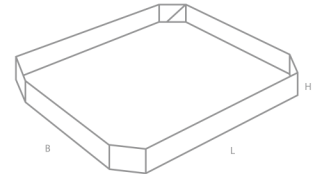
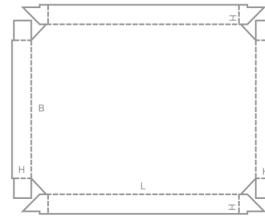

0456 | M

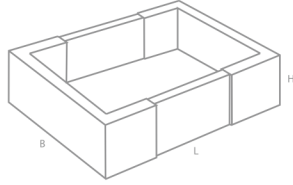
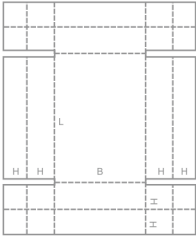

0460 | A

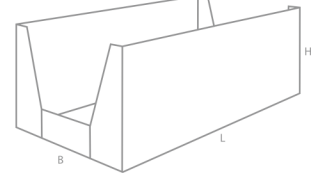
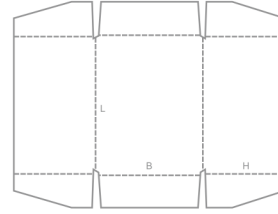

0457 | M

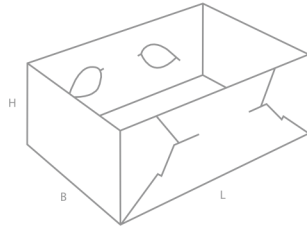
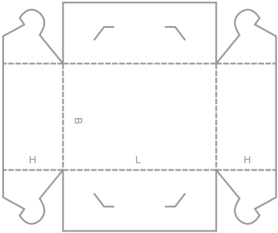

0470 | M

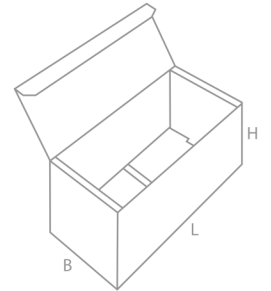
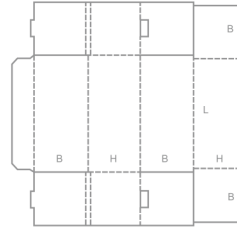

0458 | M

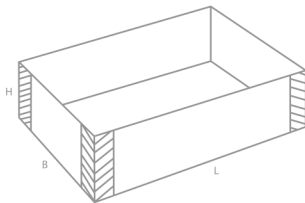
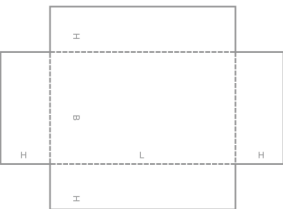

0471 | M

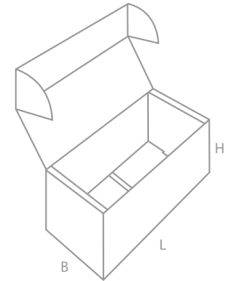
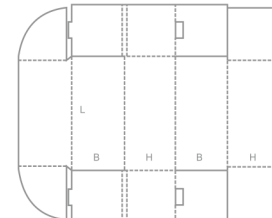

FEFCO 0400

Klasör Tipi Kutular ve Tepsiler

0472 | M

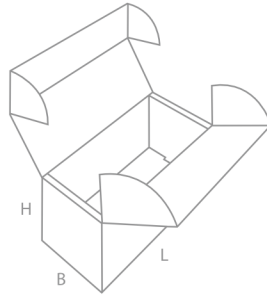
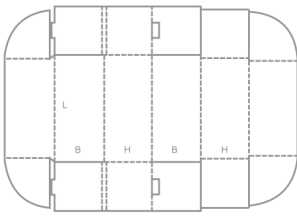

0473 | M

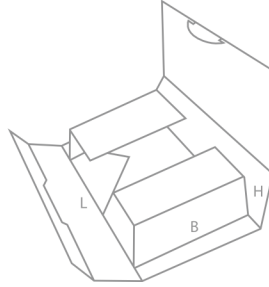
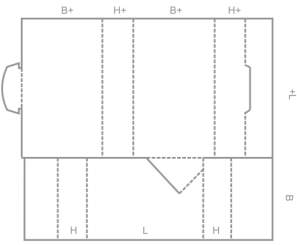

FEFCO 0500

Slayt Tipi Kutular

0501 | M

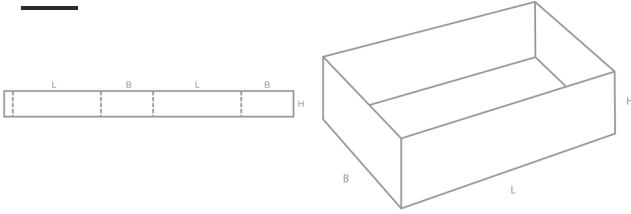

0502 | M

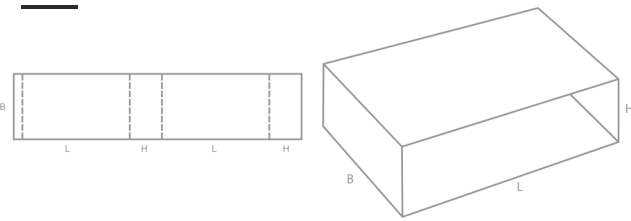

0503 | M

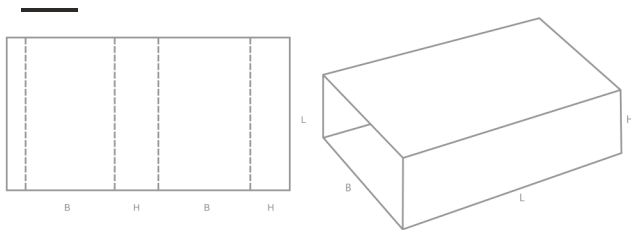

0504 | M

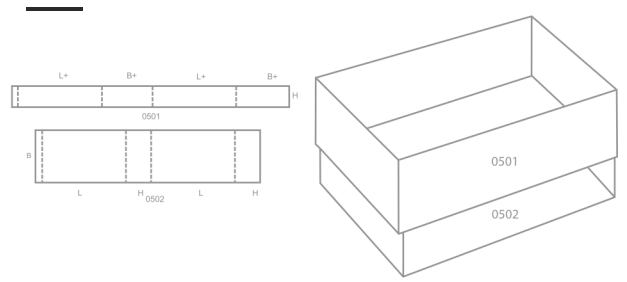

0505 | M

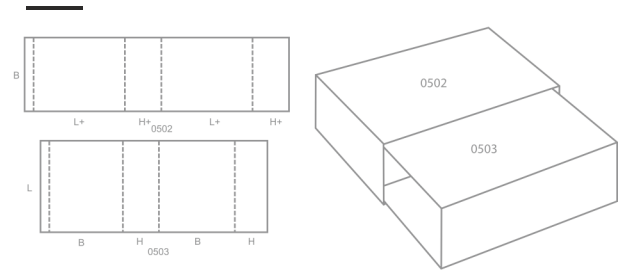

0507 | M

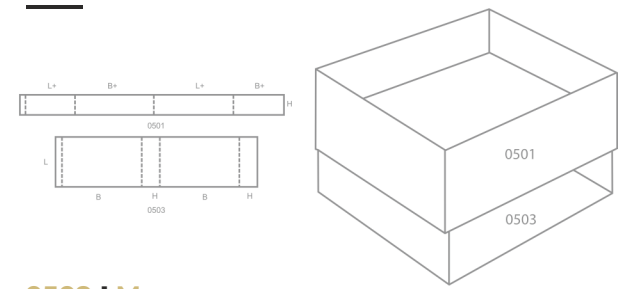

0509 | M

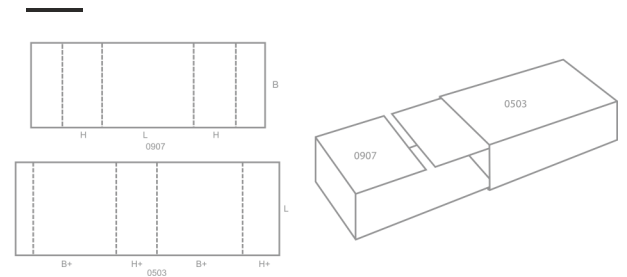

FEFCO 0500

Slayt Tipi Kutular

0510 | M

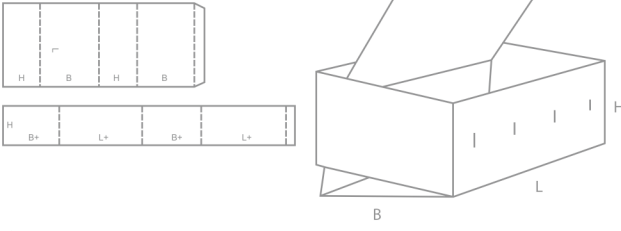

0511 | M

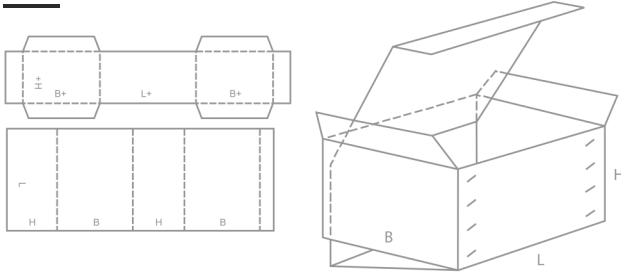

0512 | M

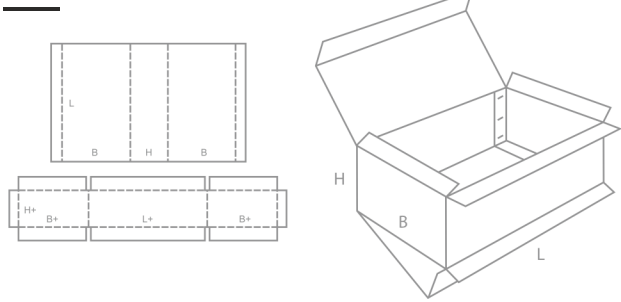

FEFCO 0600

Sert Tip Kutular

0601 | A

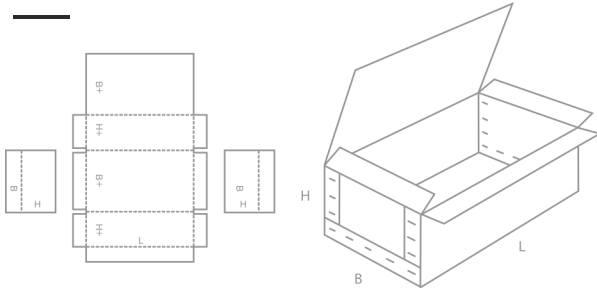

0602 | A

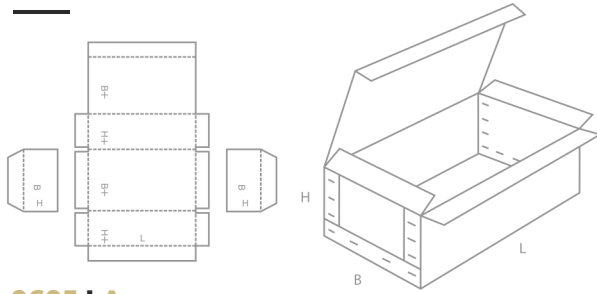

0605 | A

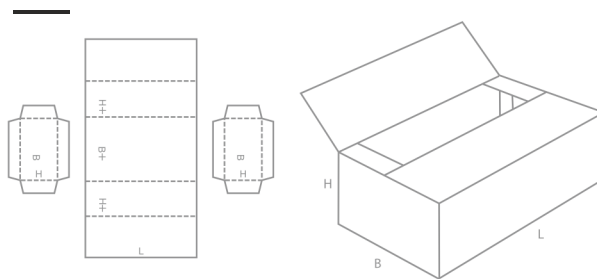

0606 | A

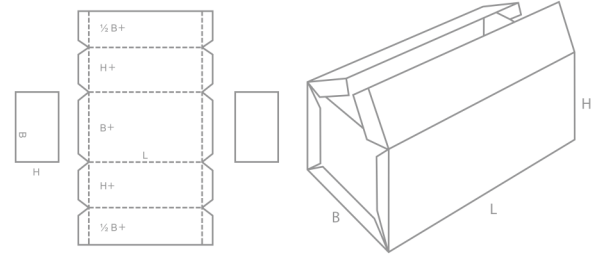

0607 | A

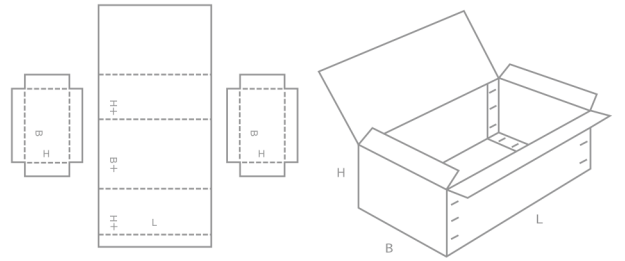

0608 | A

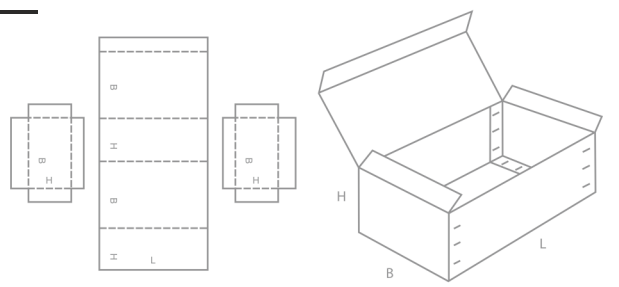

0610 | M/A

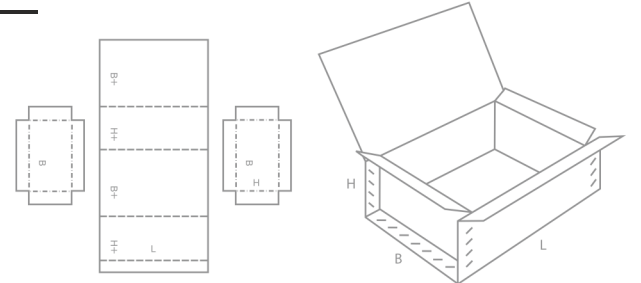

FEFCO 0600

Sert Tip Kutular

0615 | M

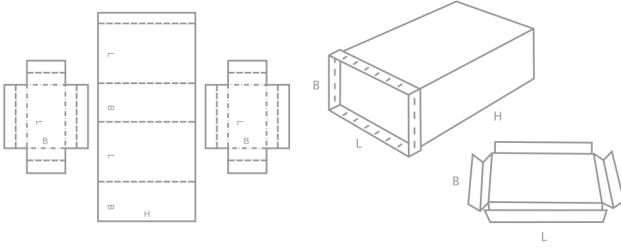

0616 | M/A

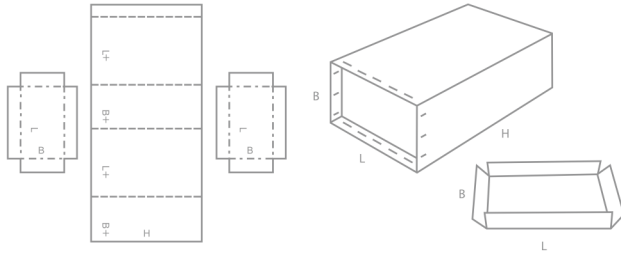

0620 | A

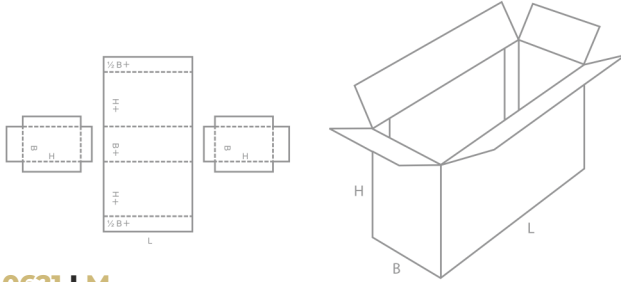

0621 | M

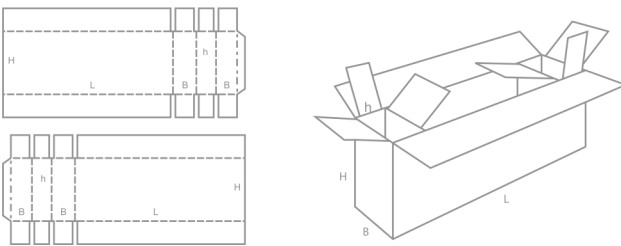

FEFCO 0700

Hazır Yapıştırılmış Kutular

0700 | M

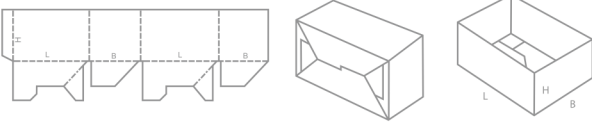

0711 | M

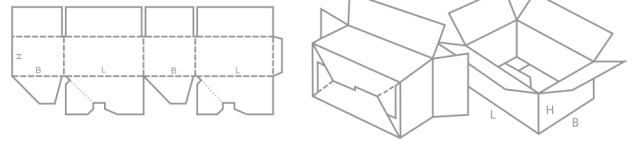

0712 | M

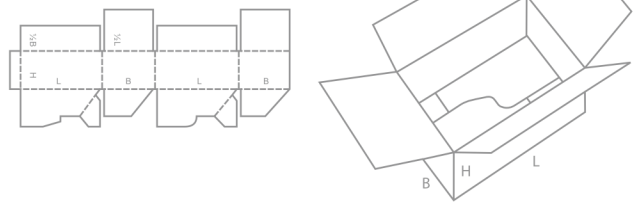

0701 | M

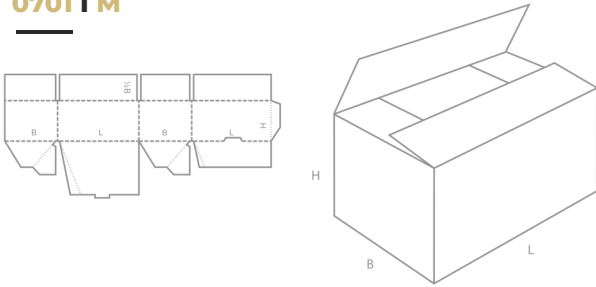

0713 | M

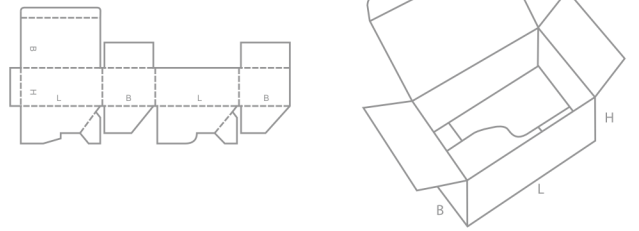

0703 | M

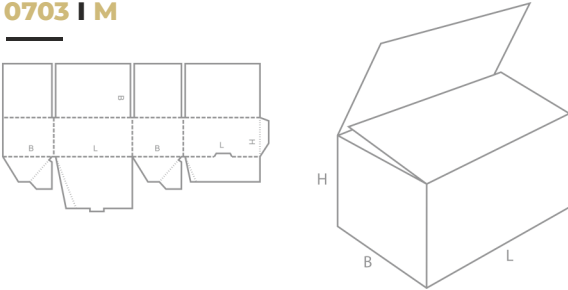

0714 | M

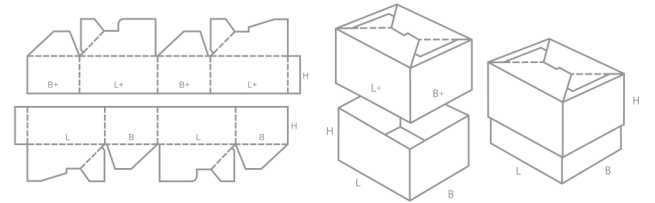

FEFCO 0700

Hazır Yapıştırılmış Kutular

0715 | M

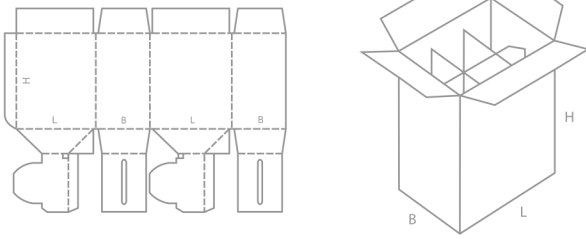

0747 | A

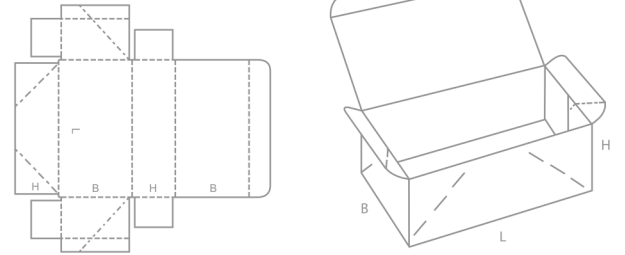

0716 | M

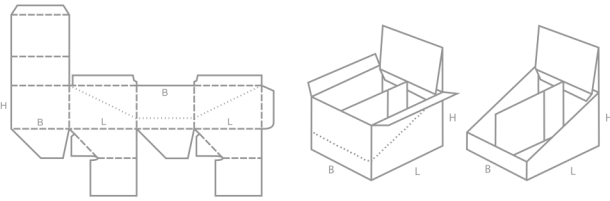

0748 | A

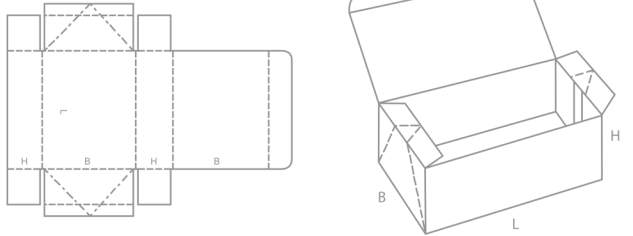

0717 | M

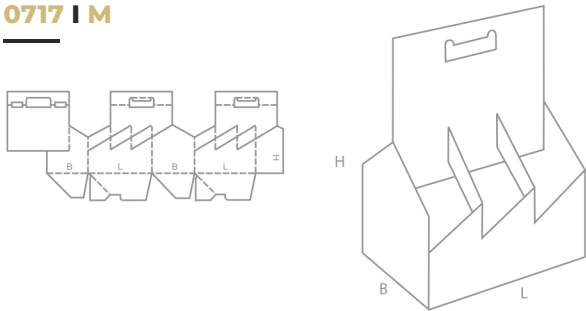

0751 | M

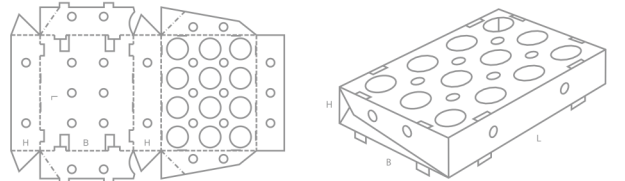

0718 | M

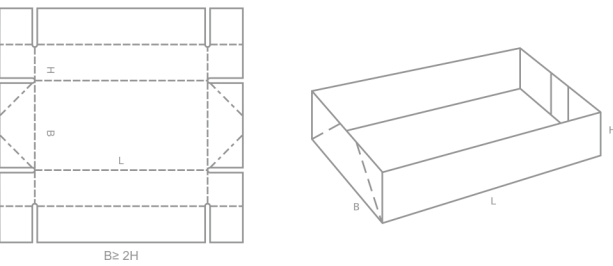

0752 | M

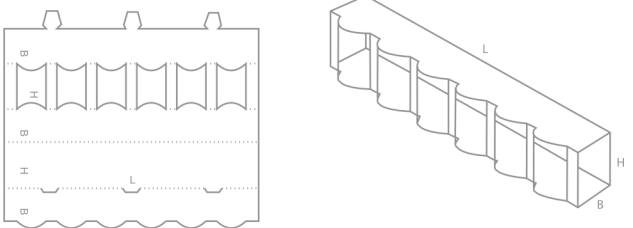

FEFCO 0700

Hazır Yapıştırılmış Kutular

0759 | M

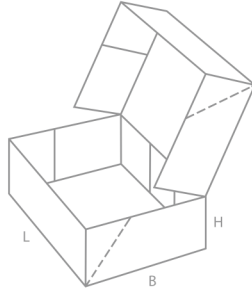
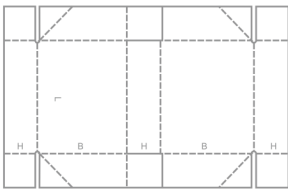

0772 | M

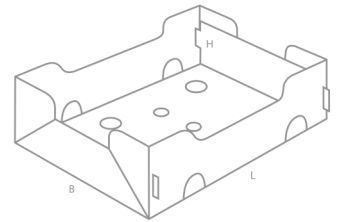
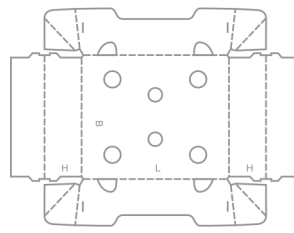

0761 | M

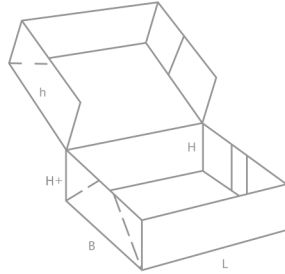
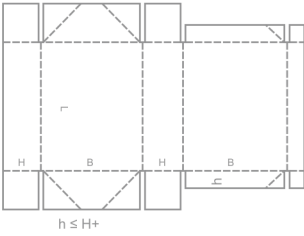

0773 | M

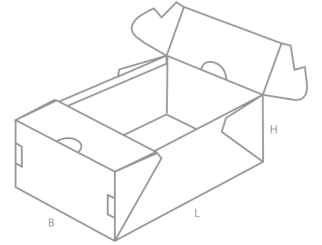
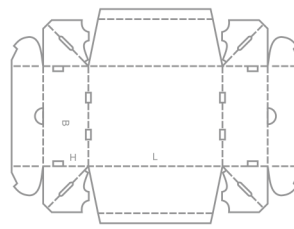

0770 | M

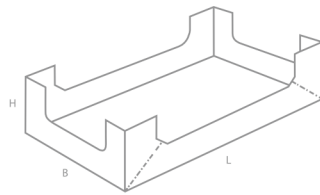
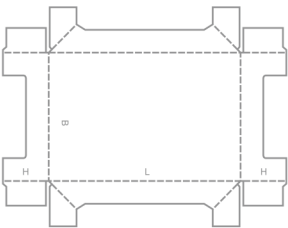

0774 | M

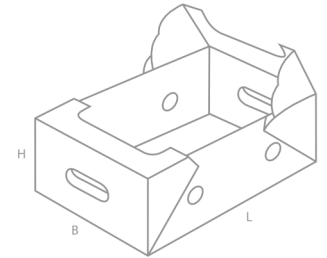
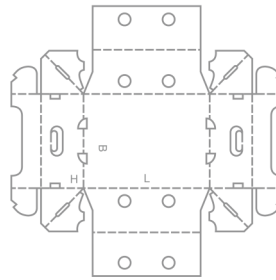

0771 | M

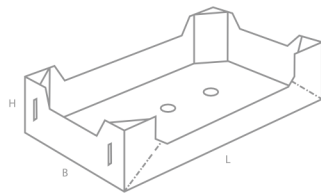
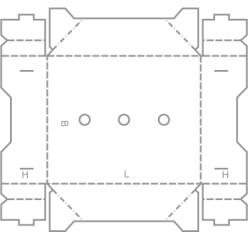

FEFCO 0900

İç Donanımlar

0900 | M

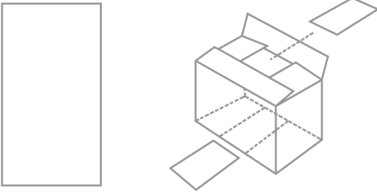

0901 | M

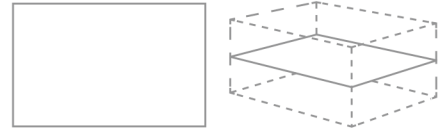

0902 | M

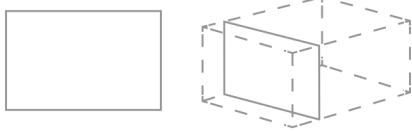

0903 | M

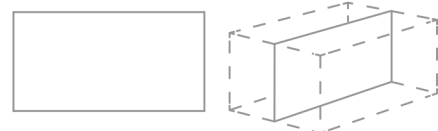

0904 | M

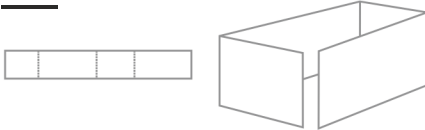

0905 | M

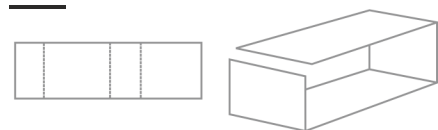

FEFCO 0900

İç Donanımlar

0906 | M

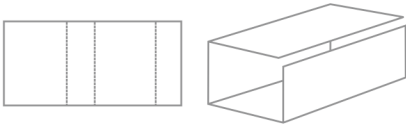

0907 | M

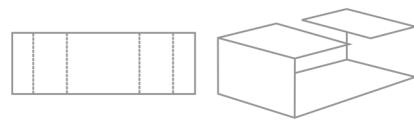

0908 | M

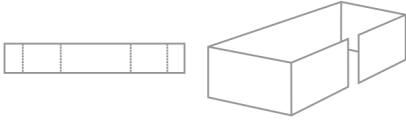

0909 | M

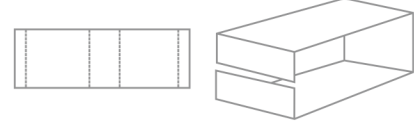

0910 | M

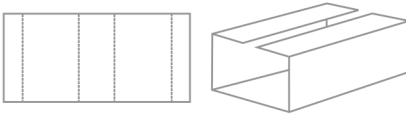

0911 | M

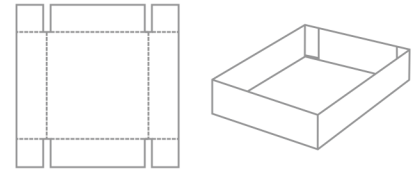

0913 | M

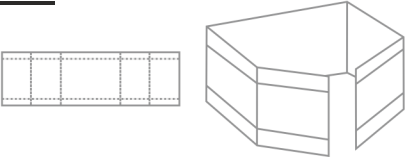

0914 | M

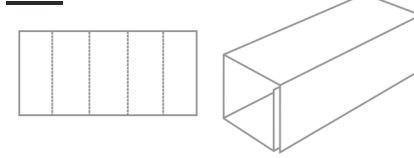

FEFCO 0900

İç Donanımlar

0920 | M

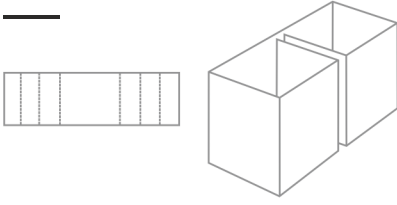

0921 | M

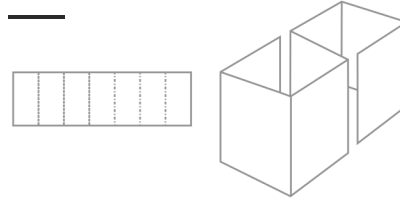

0929 | M

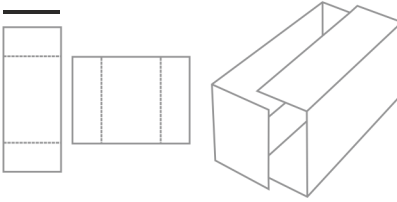

0930 | M

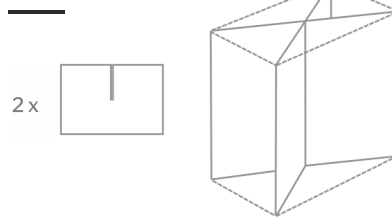

0931 | M

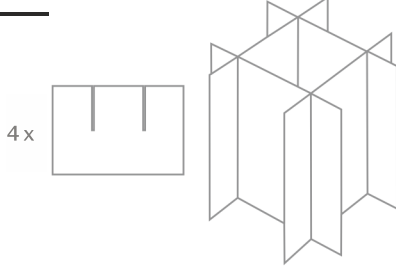

0932 | M

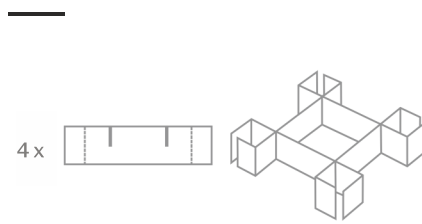

0933 | M

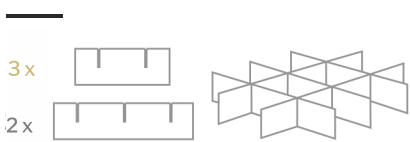

0934 | M

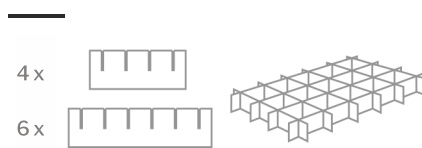

FEFCO 0900

İç Donanımlar

0935 | M

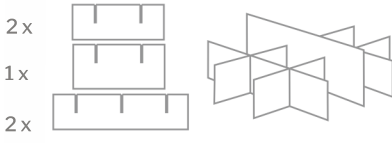

0940 | M



0941 | M



0942 | M

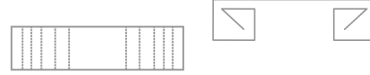

0943 | M



0944 | M



0945 | M



0946 | M



FEFCO 0900

İç Donanımlar

0947 | M



0948 | M



0949 | M

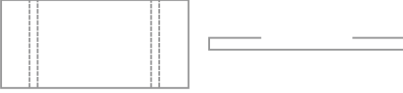

0950 | M



0951 | M

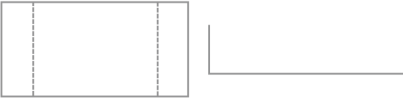

0965 | M

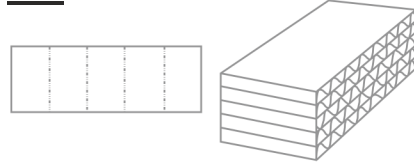

0966 | M

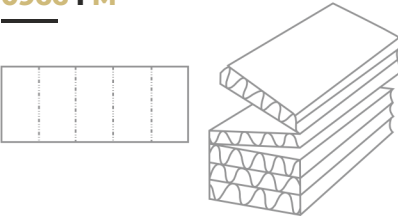

0967 | M



FEFCO 0900

İç Donanımlar

0970 | M

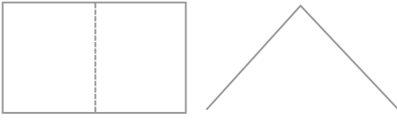

0971 | M

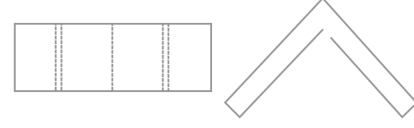

0972 | M

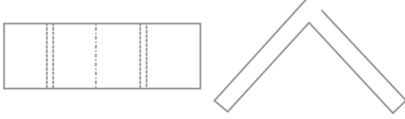

0973 | M

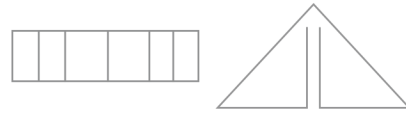

0974 | M

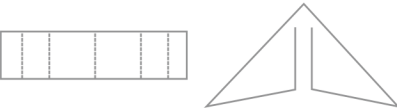

0975 | M

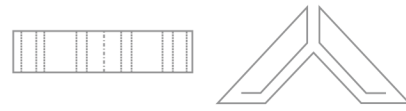

0976 | M

